

USAGE AREAS:

It is suitable for use in outdoor and indoor sports facilities, concerts and event areas.

SYSTEM DEFINITION:

The next-generation GRAND VIP fixed stadium seat, produced with the gas Inflation system, is a system that can be directly mounted on the riser without the need for metal parts.



FEATURES:

The fixed grandstand seat offers comfortable and practical use with its ergonomic design, lightweight portability, easy assembly, and durability.

GRAND VIP 101

TECHNICAL SPECIFICATIONS

1	The corrosion, which is the biggest problem for both open and closed sports facilities, is now completely preventable. The central shaft in the movement mechanism is made of hardened special alloy aluminum and assembled with aluminum washers and 304-quality stainless steel bolts. This ensures that our product will not experience rusting even in water.
2	With different options, a seating height of 45 cm can be achieved at each step, and these options can be easily assembled.
3	With UV and antioxidant additives, color fading and chalkiness are prevented, and it comes with a 5-year warranty in these aspects.
4	Burning is delayed with FR additive. This feature is certified with UL 94 - V2 test report.
5	The production is carried out using original polypropylene and special composite raw material additives, inflated by the gas injection method. This allows the product to exhibit top-level performance in terms of impact resistance.
6	Plastic ribs used in the back and seat parts are covered with 2 cm high-density foams and carefully assembled with fire-resistant synthetic leather pads. This feature provides extra comfort to the spectators.
7	The seats are produced to be resistant to breakage and disassembly by hooligans
8	Automatic closing is achieved without a spring, thanks to the weight center.
9	The front of the seating area is designed in an oval shape that does not disturb the legs.
10	The backrest is produced in a curved and ergonomic structure.
11	When the seat is closed, there is a visible seat number area.
12	To fix the seats to the step, the step forehead is drilled at four points. After cleaning the holes, steel anchors are placed, and then the product is attached to the step using M8 chrome bolts. This prevents the rusting of installation elements.



PRODUCT IMAGES



COLOURS

Standard Ral Codes

RAL 3028	RAL 5002	RAL 6029
RAL 1018	RAL 9005	RAL 9010

TECHNICAL DRAWING

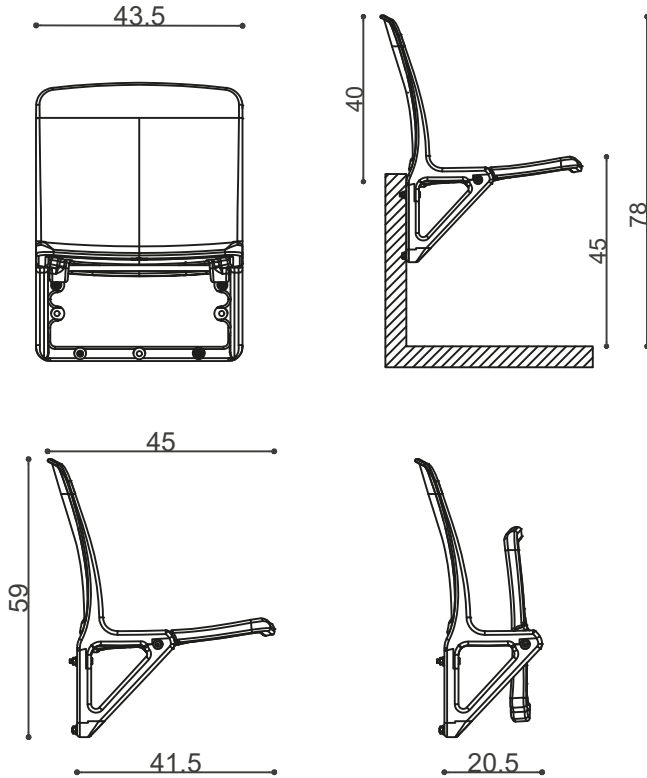

PHOTOS FROM PRODUCTION



GRAND VIP 101

APPLICATION AREAS

